



## FT12-55

## 12V 55AH Front Terminal Battery

### Characteristics

Nominal Voltage		12V
Nominal Capacity (10 hour rate)		55Ah
Capacity 25°C (77°F)	10 hour rate (5.5A)	55Ah
	3 hour rate (13.75A)	41.25 Ah
	1 hour rate (30.25A)	30.25Ah
Internal Resistance	Full Charged Battery 25°C (77°F)	≤10mΩ
Cyclic Life	50%(C <sub>10</sub> ) Depth of discharge	800Times
Float Life	25°C (77°F) Float charge at 13.8V	About 8-10 Years
	40°C (104°F)	102%
Capacity affected by Temperature (10 hour)	25°C (77°F)	100%
	0°C (32°F)	85%
	-15°C (5°F)	65%
	Capacity after 3 month storage	90%
Self-Discharge 25°C (77°F)	Capacity after 6 month storage	80%
	Capacity after 12 month storage	62%
	Charge (Constant Voltage) 25°C (77°F)	Cycle
	Float	Voltage 13.5-13.8V
Operating Temperature Range during Charging/ Discharging		-15°C to 45°C

### Product Image



### Packing

Battery (L×W×H)	mm±1	277×106×223
	inch	10.9×4.17×8.78
Box (L×W×H)	mm±2	290*118*265
	inch	11.4*4.65*10.43
Quantity Per Box		1 PCS
Net weight Per Cell		16.5Kg±150g
Net weight Per Box		16.5 Kg
Gross Weight		17.0 Kg

### Discharge Curve

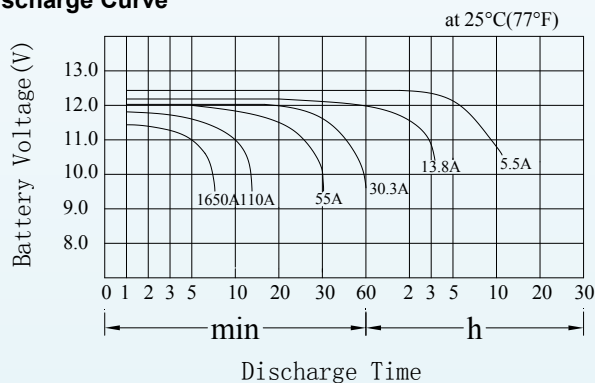

### Product Dimensions

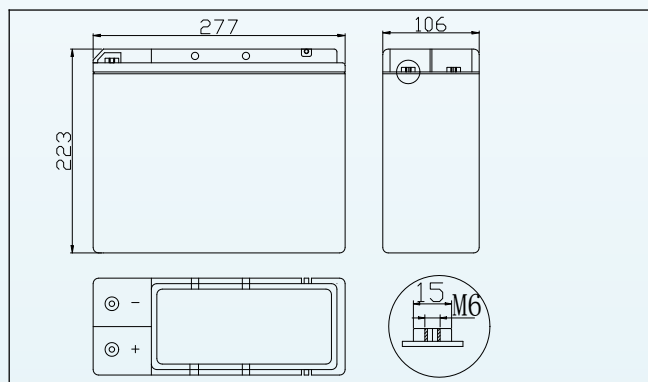

### Battery Construction

Component	Positive plate	Negative plate	Container	Safety valve	Terminal	Separator	Electrolyte
Raw Material	Lead dioxide	Lead	ABS	Rubber	Copper	Fiberglass	Sulfuric acid

### Discharge Characteristics

Voltage	Run Time (Constant Current and Power 25°C 77°F)										
	3 min	5 min	15 min	30 min	45 min	1h	2h	3h	5h	8h	10h
9.6 V	2404	2090	1183	759	567	410	231	174	116	77.0	68.2
10.2V	2310	1788	1062	677	545	405	222	171	114	75.9	67.7
10.5V	2118	1694	1001	616	534	398	215	167	112	74.8	66.6
10.8V	1936	1612	869	550	517	391	209	160	108	74.3	66.0

### Discharge Characteristics Curve

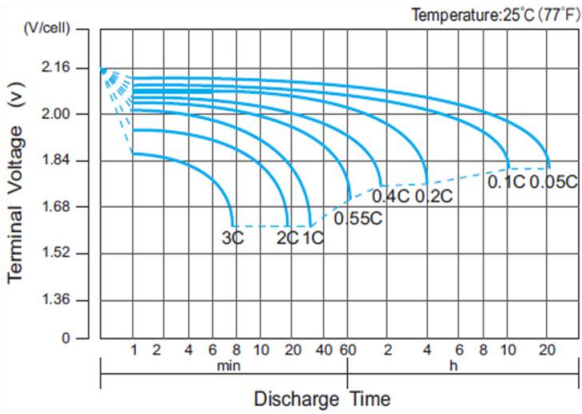

### Charging Characteristics

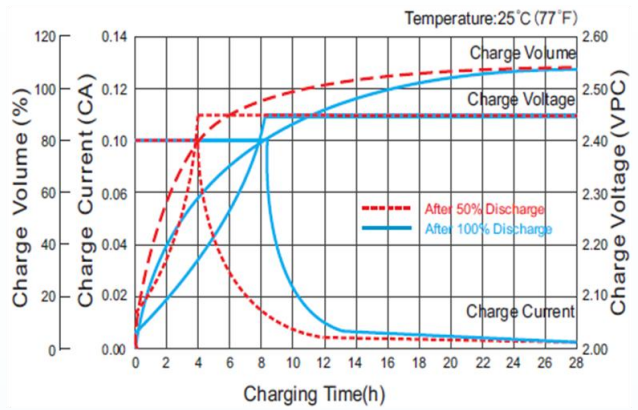

### Cycle Life vs. Depth of Discharge (25°C)

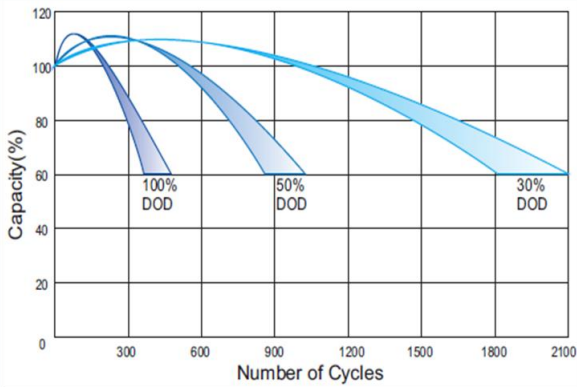

### Temperature Effects on Capacity

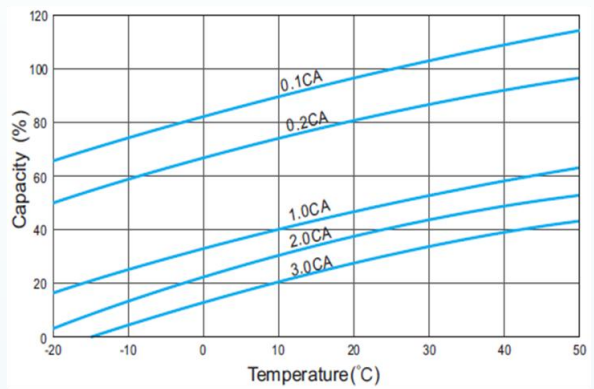

### Effect of Temperature on Long Term Life

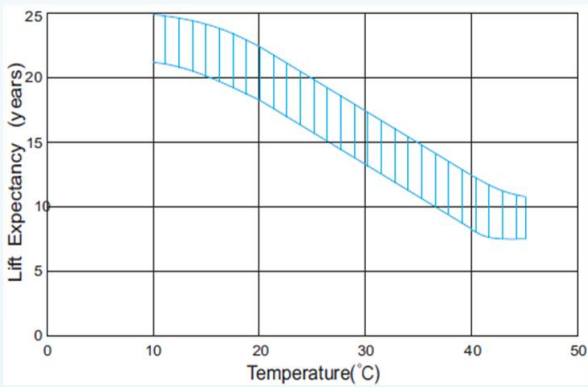

### Storage Characteristics

